

TS01
skrzydło
proste

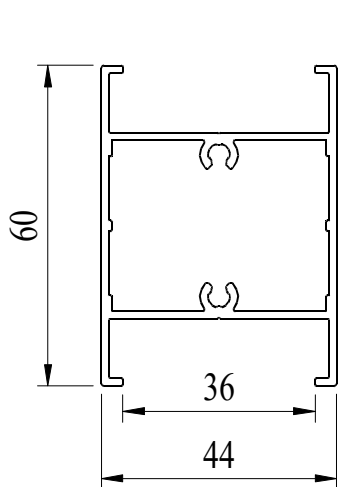

TS02
poprzeczka

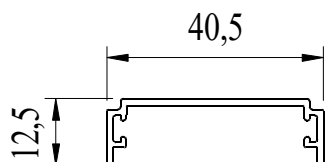

TS03
listwa do otw.

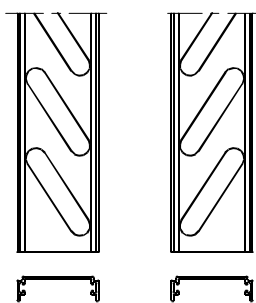

TS03R TS03L
listwa z otw. 40mm

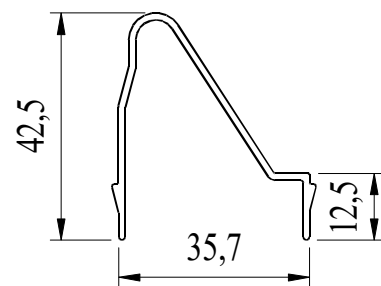

TS04
lam. startowa stała

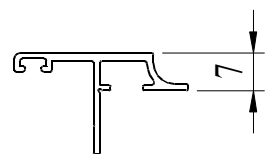

TS05
przymyk

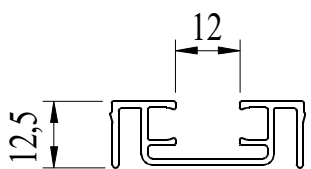

TS06
moc. lameli start.

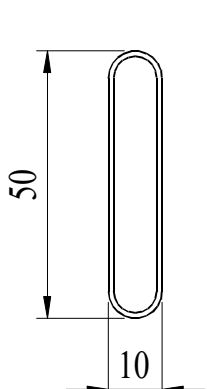

TS07
lamela stała

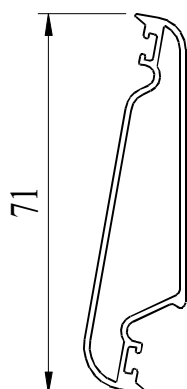

TS08
lamela ruchoma

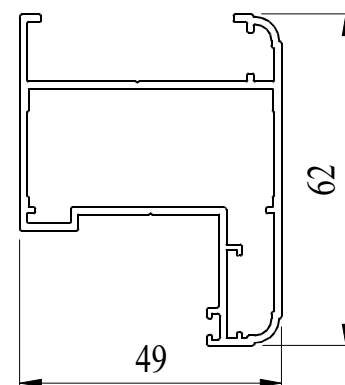

TS10
skrzydło wykł.

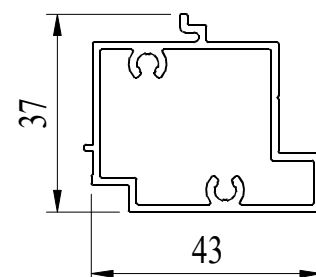

TS11
słupek ruchomy

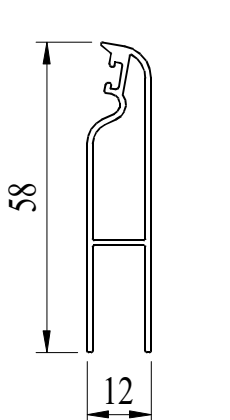

TS12
l. start. ruchoma

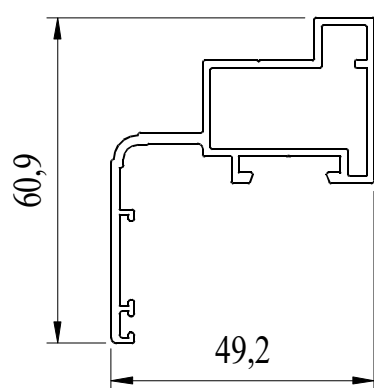

TS14
ościeżnica

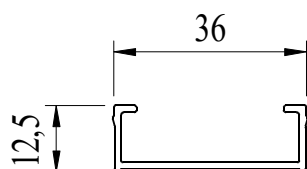

TS20
mocow. panelu 27 mm

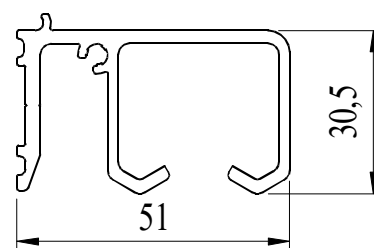

TS31
szyna

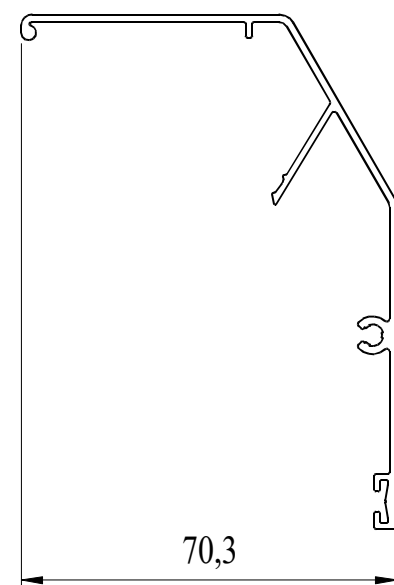

TS32
pokrywa szyny

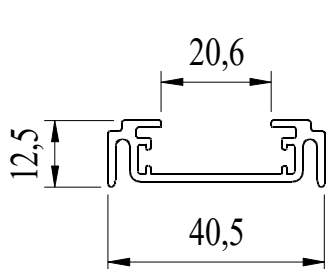

TS50
listwa row. 20 mm

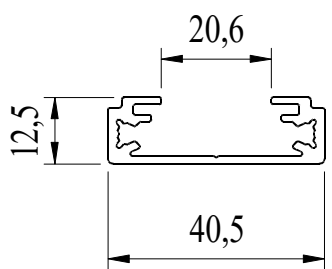

TS52
listwa row. 20 mm

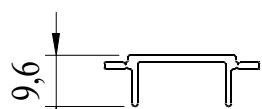

TS51
listwa mask. 20 mm

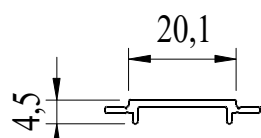

TS53
listwa mask. 20 mm

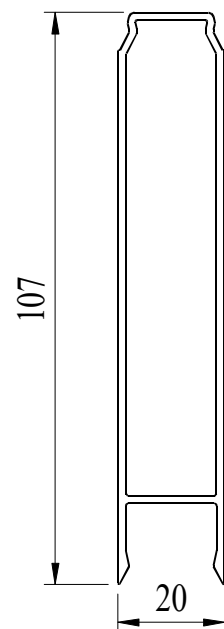

TS70
deska

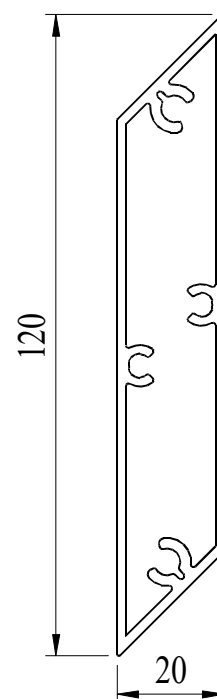

TS72
deska ukośna

ALATOMA
profile okiennicowe
skala 1:1
18.03.2022

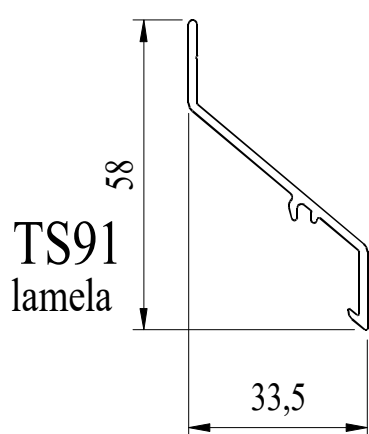

TS91
lamela

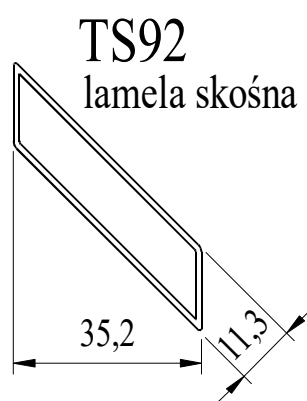

TS92
lamela skośna

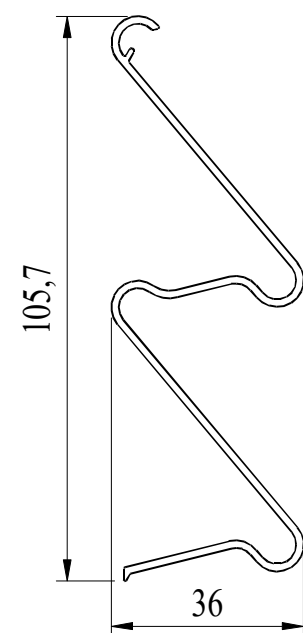

TS95
atrapa lameli